



NEXCOM International Co., Ltd.

Intelligent Platform & Services Business Unit

Edge Computing System

Neu-X102/104/1025/1045 Series

User Manual

CONTENTS

Preface

Copyright	iv
Disclaimer	iv
Acknowledgements	iv
Regulatory Compliance Statements	iv
Declaration of Conformity	iv
RoHS Compliance	v
Warranty and RMA	vi
Safety Information	viii
Installation Recommendations	viii
Safety Precautions	ix
Technical Support and Assistance	x
Conventions Used in this Manual	x
Global Service Contact Information	xi
Package Contents	xiii
Ordering Information	xiv
DDR4 Models	xiv
DDR5 Models	xiv

Chapter 1: Product Introduction

Product Overview	1
Key Features	1
Hardware Specifications	2
Physical Features	4
Front Panel	4
Rear Panel	5
Mechanical Dimensions	6

Chapter 2: Jumpers and Connectors

Before You Begin	8
Precautions	8
Jumper Settings	9
System Motherboard Overview	10
Location of Jumpers and Connectors on the Motherboard	10
Jumpers & DIP Switches	12
Clear CMOS	12
LVDS Panel Voltage Select	12
COM2 RI Select	13
eDP Panel Resolution Select	13
Connector Pin Definitions	14
Internal Connectors	14
Battery Connector	14
COM 1 Port Header	14
COM 2 Port Header	15
FAN Connector	15
DC Power Input Jack	16
Debug Port Connector	16
GPIO Connector	17
LVDS Inverter Connector	17
LVDS / eDP Panel Connector	18
M.2 Key M Connector	20
MIC-in & Line-out Connector	21
Mini PCIe Connector	22
System Reset Connector	23
SATA Connector	23



- SATA Power Connector 24
- Speaker Connector 24
- USB 2.0 Connector..... 25
- Block Diagram 26
- DDR4 Models..... 26
- DDR5 Models..... 27

Chapter 3: System Setup

- Installing a SO-DIMM Memory Module & M.2 Key M SSD Module 28
- Installing a Wi-Fi or LTE Module 29
 - Installing a Wi-Fi Module 30
 - Installing an LTE Module..... 31
- Assembling the Antennas 32
- Assembling the Remote Switch Cable 33

Chapter 4: BIOS Setup

- About BIOS Setup 34
- When to Configure the BIOS..... 34
- Default Configuration..... 35
- Entering Setup 35
- Legends 35
- BIOS Setup Utility..... 37
 - Main..... 37
 - Advanced 38
 - Security..... 47
 - Boot 48
 - Save & Exit 49

APPENDIX A: GPIO Programming Guide

Appendix B: Watchdog Timer Setting



PREFACE

Copyright

This publication, including all photographs, illustrations and software, is protected under international copyright laws, with all rights reserved. No part of this manual may be reproduced, copied, translated or transmitted in any form or by any means without the prior written consent from NEXCOM International Co., Ltd.

Disclaimer

The information in this document is subject to change without prior notice and does not represent commitment from NEXCOM International Co., Ltd. However, users may update their knowledge of any product in use by constantly checking its manual posted on our website: <http://www.nexcom.com>. NEXCOM shall not be liable for direct, indirect, special, incidental, or consequential damages arising out of the use of any product, nor for any infringements upon the rights of third parties, which may result from such use. Any implied warranties of merchantability or fitness for any particular purpose is also disclaimed.

Acknowledgements

Neu-X102/104/1025/1045 series are trademarks of NEXCOM International Co., Ltd. All other product names mentioned herein are registered trademarks of their respective owners.

Regulatory Compliance Statements

This section provides the FCC compliance statement for Class A devices and describes how to keep the system CE compliant.

Declaration of Conformity

FCC

This equipment has been tested and verified to comply with the limits for a Class A digital device, pursuant to Part 15 of FCC Rules. These limits are designed to provide reasonable protection against harmful interference when the equipment is operated in a commercial environment. This equipment generates, uses, and can radiate radio frequency energy and, if not installed and used in accordance with the instructions, may cause harmful interference to radio communications. Operation of this equipment in a residential area (domestic environment) is likely to cause harmful interference, in which case the user will be required to correct the interference (take adequate measures) at their own expense.

CE

The product(s) described in this manual complies with all applicable European Union (CE) directives if it has a CE marking. For computer systems to remain CE compliant, only CE-compliant parts may be used. Maintaining CE compliance also requires proper cable and cabling techniques.

RoHS Compliance



NEXCOM RoHS Environmental Policy and Status Update

NEXCOM is a global citizen for building the digital infrastructure. We are committed to providing green products and services, which are compliant with European Union RoHS (Restriction on Use of Hazardous Substance in Electronic Equipment) directive 2011/65/EU, to be your trusted green partner and to protect our environment.

RoHS restricts the use of Lead (Pb) < 0.1% or 1,000ppm, Mercury (Hg) < 0.1% or 1,000ppm, Cadmium (Cd) < 0.01% or 100ppm, Hexavalent Chromium (Cr6+) < 0.1% or 1,000ppm, Polybrominated biphenyls (PBB) < 0.1% or 1,000ppm, and Polybrominated diphenyl Ethers (PBDE) < 0.1% or 1,000ppm.

In order to meet the RoHS compliant directives, NEXCOM has established an engineering and manufacturing task force to implement the introduction of green products. The task force will ensure that we follow the standard NEXCOM development procedure and that all the new RoHS components and new manufacturing processes maintain the highest industry quality levels for which NEXCOM are renowned.

The model selection criteria will be based on market demand. Vendors and suppliers will ensure that all designed components will be RoHS compliant.

How to recognize NEXCOM RoHS Products?

For existing products where there are non-RoHS and RoHS versions, the suffix "(LF)" will be added to the compliant product name.

All new product models launched after January 2013 will be RoHS compliant. They will use the usual NEXCOM naming convention.

Warranty and RMA

NEXCOM Warranty Period

NEXCOM manufactures products that are new or equivalent to new in accordance with industry standard. NEXCOM warrants that products will be free from defect in material and workmanship for 2 years, beginning on the date of invoice by NEXCOM.

NEXCOM Return Merchandise Authorization (RMA)

- Customers shall enclose the “NEXCOM RMA Service Form” with the returned packages.
- Customers must collect all the information about the problems encountered and note anything abnormal or, print out any on-screen messages, and describe the problems on the “NEXCOM RMA Service Form” for the RMA number apply process.
- Customers can send back the faulty products with or without accessories (manuals, cable, etc.) and any components from the card, such as CPU and RAM. If the components were suspected as part of the problems, please note clearly which components are included. Otherwise, NEXCOM is not responsible for the devices/parts.
- Customers are responsible for the safe packaging of defective products, making sure it is durable enough to be resistant against further damage and deterioration during transportation. In case of damages occurred during transportation, the repair is treated as “Out of Warranty.”
- Any products returned by NEXCOM to other locations besides the customers’ site will bear an extra charge and will be billed to the customer.

Repair Service Charges for Out-of-Warranty Products

NEXCOM will charge for out-of-warranty products in two categories, one is basic diagnostic fee and another is component (product) fee.

System Level

- Component fee: NEXCOM will only charge for main components such as SMD chip, BGA chip, etc. Passive components will be repaired for free, ex: resistor, capacitor.
- Items will be replaced with NEXCOM products if the original one cannot be repaired. Ex: motherboard, power supply, etc.
- Replace with 3rd party products if needed.
- If RMA goods can not be repaired, NEXCOM will return it to the customer without any charge.

Board Level

- Component fee: NEXCOM will only charge for main components, such as SMD chip, BGA chip, etc. Passive components will be repaired for free, ex: resistors, capacitors.
- If RMA goods can not be repaired, NEXCOM will return it to the customer without any charge.

Board Level

- Component fee: NEXCOM will only charge for main components, such as SMD chip, BGA chip, etc. Passive components will be repaired for free, ex: resistors, capacitors.
- If RMA goods can not be repaired, NEXCOM will return it to the customer without any charge.

Warnings

Read and adhere to all warnings, cautions, and notices in this guide and the documentation supplied with the chassis, power supply, and accessory modules. If the instructions for the chassis and power supply are inconsistent with these instructions or the instructions for accessory modules, contact the supplier to find out how you can ensure that your computer meets safety and regulatory requirements.

Cautions

- Electrostatic discharge (ESD) can damage system components. Do the described procedures only at an ESD workstation. If no such station is available, you can provide some ESD protection by wearing an antistatic wrist strap and attaching it to a metal part of the computer chassis.
- Proper grounding is essential to protect against electrical surges and ensure stable operation. Always connect the grounding wire.

Safety Information

Before installing and using the device, note the following precautions:

- Read all instructions carefully.
- Do not place the unit on an unstable surface, cart, or stand.
- Follow all warnings and cautions in this manual.
- When replacing parts, ensure that your service technician uses parts specified by the manufacturer.
- Avoid using the system near water, in direct sunlight, or near a heating device.
- The load of the system unit does not solely rely for support from the rackmounts located on the sides. Firm support from the bottom is highly necessary in order to provide balance stability.
- The computer is provided with a battery-powered real-time clock circuit. There is a danger of explosion if battery is incorrectly replaced. Replace only with the same or equivalent type recommended by the manufacturer. Discard used batteries according to the manufacturer's instructions.

Installation Recommendations

Ensure you have a stable, clean working environment. Dust and dirt can get into components and cause a malfunction. Use containers to keep small components separated.

Adequate lighting and proper tools can prevent you from accidentally damaging the internal components. Most of the procedures that follow require only a few simple tools, including the following:

- A Philips screwdriver
- A flat-tipped screwdriver
- A grounding strap
- An anti-static pad

Using your fingers can disconnect most of the connections. It is recommended that you do not use needle-nose pliers to disconnect connections as these can damage the soft metal or plastic parts of the connectors.

Safety Precautions

1. Read these safety instructions carefully.
2. Keep this User Manual for later reference.
3. Disconnect this equipment from any AC outlet before cleaning. Use a damp cloth. Do not use liquid or spray detergents for cleaning.
4. For plug-in equipment, the power outlet socket must be located near the equipment and must be easily accessible.
5. Keep this equipment away from humidity.
6. Put this equipment on a stable surface during installation. Dropping it or letting it fall may cause damage.
7. The openings on the enclosure are for air convection to protect the equipment from overheating. DO NOT COVER THE OPENINGS.
8. Make sure the voltage of the power source is correct before connecting the equipment to the power outlet.
9. Place the power cord in a way so that people will not step on it. Do not place anything on top of the power cord. Use a power cord that has been approved for use with the product and that it matches the voltage and current marked on the product's electrical range label. The voltage and current rating of the cord must be greater than the voltage and current rating marked on the product.
10. All cautions and warnings on the equipment should be noted.
11. If the equipment is not used for a long time, disconnect it from the power source to avoid damage by transient overvoltage.
12. Never pour any liquid into an opening. This may cause fire or electrical shock.
13. Never open the equipment. For safety reasons, the equipment should be opened only by qualified service personnel.
14. If one of the following situations arises, get the equipment checked by service personnel:
 - a. The power cord or plug is damaged.
 - b. Liquid has penetrated into the equipment.
 - c. The equipment has been exposed to moisture.
 - d. The equipment does not work well, or you cannot get it to work according to the user's manual.
 - e. The equipment has been dropped and damaged.
 - f. The equipment has obvious signs of breakage.
15. Do not place heavy objects on the equipment.
16. The unit uses a three-wire ground cable which is equipped with a third pin to ground the unit and prevent electric shock. Do not defeat the purpose of this pin. If your outlet does not support this kind of plug, contact your electrician to replace your obsolete outlet.
17. Equipment is intended for installation in Restricted Access Area" (Instruction)/"Les matériels sont destinés à être installés dans des EMPLACEMENTS À ACCÈS RESTREINT" (Instruction).
18. **CAUTION:** Risk of fire or explosion if the battery is replaced by an incorrect type. Dispose of Used Batteries According to the Instructions. **ATTENTION:** Risque d'explosion si la batterie est remplacée par un type incorrect. Mettre au rebus les batteries usagées selon les instructions.
19. Please ensure to connect the power cord of the power adapter to a socket-outlet with earthing connection.
20. This product is intended to be supplied by a Listed Power Adapter or DC power source, rated 12Vdc, minimum 2.0A, minimum T ma=50 degree C, minimum altitude of operation=2000m, and evaluated in accordance to UL/IEC 60950-1 and/or UL/IEC 62368-1. If further assistance is needed, please contact NEXCOM International Co., Ltd. (UL file owner or brand owner) for further information.

Technical Support and Assistance

1. For the most updated information of NEXCOM products, visit NEXCOM's website at www.nexcom.com.
2. For technical issues that require contacting our technical support team or sales representative, please have the following information ready before calling:
 - Product name and serial number
 - Detailed information of the peripheral devices
 - Detailed information of the installed software (operating system, version, application software, etc.)
 - A complete description of the problem
 - The exact wordings of the error messages

Warning!

1. Handling the unit: carry the unit with both hands and handle it with care.
2. Maintenance: to keep the unit clean, use only approved cleaning products or clean with a dry cloth.

Conventions Used in this Manual



Warning:

Information about certain situations, which if not observed, can cause personal injury. This will prevent injury to yourself when performing a task.



Caution:

Information to avoid damaging components or losing data.



Note:

Provides additional information to complete a task easily.

Global Service Contact Information

Headquarters

NEXCOM International Co., Ltd.

9F, No. 920, Zhongzheng Rd.,
Zhonghe District, New Taipei City, 235015,
Taiwan, R.O.C.
Tel: +886-2-8226-7786
Fax: +886-2-8226-7782
www.nexcom.com

Taiwan

NexAIoT Headquarters

Industry 4.0 and Cloud Services

13F, No.922, Zhongzheng Rd.,
Zhonghe District, New Taipei City,
235015, Taiwan, R.O.C.
Tel: +886-2-8226-7796
Fax: +886-2-8226-7926
Email: contact@nexcom.com.tw
www.nexaiot.com

NexAIoT Co., Ltd. Taichung Office

16F, No.250, Sec.2, Chongde Rd.,
Beitun District,
Taichung City, 406503, Taiwan, R.O.C.
Tel: +886-4-2249-1179
Fax: +886-4-2249-1172
Email: contact@nexcom.com.tw
www.nexaiot.com

NexCOBOT Taiwan Co., Ltd.

13F, No.916, Zhongzheng Rd.,
Zhonghe District,
New Taipei City, 235015, Taiwan, R.O.C.
Tel: +886-2-8226-7786
Fax: +886-2-8226-7926
Email: contact@nexcom.com.tw
www.nexcobot.com

GreenBase Technology Corp.

13F, No.922, Zhongzheng Rd.,
Zhonghe District,
New Taipei City, 235015, Taiwan, R.O.C.
Tel: +886-2-8226-7786
Fax: +886-2-8226-7900
Email: info@greenbase.com.tw
www.greenbase.com.tw

DivioTec Inc.

29F-1A, No.97, Sec.4, ChongXin Rd.,
Sancong District,
New Taipei City, 241513, Taiwan, R.O.C.
Tel: +886-2-8976-3077
Email: sales@diviotec.com
www.diviotec.com

AIoT Cloud Corp.

13F, No.922, Zhongzheng Rd.,
Zhonghe District,
New Taipei City, 23586, Taiwan, R.O.C.
Tel: +886-2-8226-7786
Fax: +886-2-8226-7782
Email: info@aiotcloud.dev
www.aiotcloud.dev

EMBUX TECHNOLOGY CO., LTD.

13F, No.916, Zhongzheng Rd.,
Zhonghe District,
New Taipei City, 235015, Taiwan, R.O.C.
Tel: +886-2-8226-7786
Fax: +886-2-8226-7782
Email: info@embux.com
www.embux.com

TMR TECHNOLOGIES CO., LTD.

13F, No.916, Zhongzheng Rd.,
Zhonghe District,
New Taipei City, 23586, Taiwan, R.O.C.
Tel: +886-2-8226-7786
Fax: +886-2-8226-7782
Email: services@tmrtek.com
www.nexcom.com

China

NEXCOM Surveillance Technology Corp.

Floor 8, Building B3, Xiufeng Industrial Zone, Gan-Keng Community, Buji Street, LongGang District, ShenZhen, 518112, China

Tel: +86-755-8364-7768

Fax: +86-755-8364-7738

Email: info@greenbase.com.tw

www.greenbase.com.tw

NEXCOM Shanghai

Room 406-407, Building C, No 154, Lane 953, Jianchuan Road, Minhang District, Shanghai, 201108, China

Tel: +86-21-5278-5868

Fax: +86-21-3251-6358

Email: sales@nexcom.cn

www.nexcom.cn

NEXGOL Chongqing

1st Building No.999,
Star Boulevard, Yongchuan Dist,
Chongqing City, 402160, China

Tel: +86-23-4960-9080

Fax: +86-23-4966-5855

Email: sales@nexgol.com.cn

<https://www.nexgol.com/>

Beijing NexGemo Technology Co.,Ltd.

Room 205, No.1, Fazhan Road., Beijing International Information Industry Base, Changping District, Beijing, 102206, China

Tel: +86-10-8072-2025

Fax: +86-10-8072-2022

Email: sales@nexgemo.cn

www.nexgemo.com

Japan

NEXCOM Japan

9F, Tamachi Hara Bldg.,
4-11-5, Shiba Minato-ku,
Tokyo, 108-0014, Japan

Tel: +81-3-5419-7830

Fax: +81-3-5419-7832

Email: sales@nexcom-jp.com

www.nexcom-jp.com

USA

NEXCOM USA

41300 Boyce Rd.,
Fremont CA 94538, USA

Tel: +1-510-656-2248

Fax: +1-510-656-2158

Email: sales@nexcom.com

www.nexcomusa.com

Package Contents

Before continuing, please verify the contents of the product package. The items included are listed in the table below.

Item	Part Number	Name	Description	Qty
1	5060200503X00	Thermal Pad for Memory	THERMAL PAD E-LIN 65x20x1.0mm K=1.4W/mk S3S	1
2	5060200356X00	Thermal Pad for M.2	THERMAL PAD APUS:3A2020002001500 20x20x1.5mm XR-PE	1
3	50311F0144X00	Screw for M.2	I HEAD SCREW LONG FEI: M3x4mm NI NYLOK	1
4	5060900226X00	Mini-Card Bracket	MINI PCIe BRACKET CHYUAN-JYH 29x30x2.1mm SPCC t=1.0mm NI	1
5	50311F0295X00	Screws for Mini-Card Bracket	Flat Head Screw Long Fei: 2x4 Nylok NIGP F2x4 NIGP Nylok	1
6	50311F0330X00	Screw for mPCIe	ROUND HEAD SCREW LONG FEI:P2x3 ISO+NYLON P2x3 NI NYLOK	2
7	7400060068X00	Power Adapter	Power Adapter for NDiS B116 EDAC:EA10681N(T42)	1

Ordering Information

The following provides ordering information.

DDR4 Models

Neu-X102-N50 (P/N: 10W10X10200X0)

Intel® Processor N50, slim, and fanless system

Neu-X102-N97 (P/N: 10W10X10201X0)

Intel® Processor N97, slim, and fanless system

Neu-X102-i3 (P/N: 10W10X10205X0)

Intel® Core™ i3-N305 Processor, slim, and fanless system

Neu-X104-N150 (P/N: 10W10X10401X0)

Intel® Processor N150, slim, and fanless system

Neu-X104-i3 (P/N: 10W10X10402X0)

Intel® Core™ 3 Processor N355, slim, and fanless system

DDR5 Models

Neu-X1025-N50 (P/N: 10W10X10213X0)

Intel® Processor N50, slim, and fanless system

Neu-X1025-N97 (P/N: 10W10X10214X0)

Intel® Processor N97, slim, and fanless system

Neu-X1025-N305 (P/N: 10W10X10215X0)

Intel® Core™ i3-N305 Processor, slim, and fanless system

Neu-X1045-N150 (P/N: 10W10X10406X0)

Intel® Processor N150, slim, and fanless system

Neu-X1045-N355 (P/N: 10W10X10407X0)

Intel® Core™ 3 Processor N355, slim, and fanless system

CHAPTER 1: PRODUCT INTRODUCTION

Product Overview

**Neu-X102-N50 / Neu-X104-N150 /
Neu-X1025-N50 / Neu-X1045-N150**



Front Panel



Rear Panel

**Neu-X102-N97 / Neu-X102-i3 / Neu-X104-i3 /
Neu-X1025-N97 / Neu-X1025-N305 / Neu-X1045-N355**



Front Panel



Rear Panel

Key Features

- Intel® Alder Lake-N/Twin Lake-N processors
- Slim compact chassis and fanless design
- 1 x DDR4 / DDR5 SO-DIMM socket, up to 16GB (N97 supports up to 32GB)
- Support 2 x HDMI® 1.4b output
- TPM 2.0 module onboard design for security
- 1 x M.2 2242 Key M for supporting PCIe & SATA storage device
- Mini PCIe slot supports Wi-Fi 6/6E and LTE module
- Support Power Input 12V DC

Hardware Specifications

Processor

- Intel® Processor N50, TDP 6W
- Intel® Processor N97, TDP 12W
- Intel® Core™ i3-N305 Processor, TDP 15W
- Intel® Processor N150, PBP 6W
- Intel® Core™ 3 Processor N355, PBP 15W

Integrated Graphics

- Intel® UHD Graphics

Memory

- 1 x DDR4 3200 SO-DIMM socket, non-ECC, up to 16GB (N97 supports up to 32GB)
- 1 x DDR5 4800 SO-DIMM socket, non-ECC, up to 16GB (N97 supports up to 32GB)

I/O Interface Front

- 2 x RJ45 with LEDs for 2.5GbE LAN
- 2 x HDMI® 1.4b, 3840 x 2160@30Hz
- 4 x USB 3.2
- 1 Power button with LED
- 1 x DC in jack with lock

I/O Interface Rear

- 2 x Antenna holes
- 1 x Remote power switch jack
- 1 x COM port (RS-232/422/485)
- 1 x Storage active LED

I/O Interface Internal

- 1 x COM port connector (RS-232, RI/5V/12V)
- 1 x Line out audio connector
- 2 x (1 x 6P) Headers, for 3 x USB 2.0 port

Expansion Slot

- 1 x Mini PCIe connector with SIM slot (nano), supports Wi-Fi / LTE module

Storage

- 1 x M.2 Key M 2242 for supporting SATA & PCIe signal

Power Supply

- 1 x External 60W AC/DC power adapter with lock (Power adapter is included)
- Input: 100V AC to 240V AC
- Output: +12V DC

Environment

- Operating temperature: -5°C~50°C ambient with air flow
- Storage temperature: -20°C~80°C
- Humidity: 95% (non-condensing)
- Shock protection: 50G peak acceleration, 11ms according to IEC 60068-2-27
- Vibration protection
 - Random: 2Grms@5~500Hz, IEC 60068-2-64
 - Sinusoidal: 2G@5~500Hz, IEC 60068-2-6

Certification

- CE (EMC EN55035 + EN55032)
- FCC Class A (EMI Part 15B)
- LVD (EN62368-1)
- UL/CUL (62368-1)

Mechanical

- Neu-X102-N50 / Neu-X104-N50 / Neu-X1025-N50 / Neu-X105-N150:
179.5mm (D) x 106mm (W) x 37mm (H) (with mount bracket)
- Neu-X102-N97 / Neu-X102-i3 / Neu-X104-i3 / Neu-X1025-N97 /
Neu-X1025-N305 / Neu-X1045-N355:
203.5mm (D) x 106mm (W) x 40mm (H) (with mount bracket)

Operating System

- Windows 11
- Windows 10 64-bit
- Linux 22.04 above

Physical Features

Front Panel



1. 12V DC input
2. Power button
3. USB 3.2 Type-A
4. 2.5GbE LAN ports
5. HDMI® 1.4

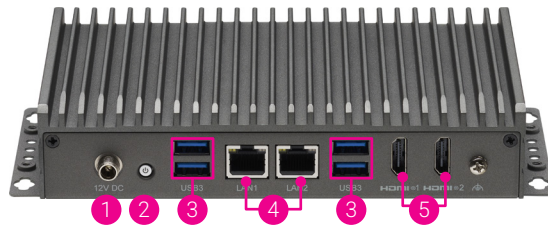

Rear Panel



- 6. Antenna connector covers
- 7. Power remote switch jack
- 8. COM port
- 9. Storage LED



Mechanical Dimensions

Neu-X102-N50, Neu-X1025-N50
 Neu-X104-N150, Neu-X1045-N150

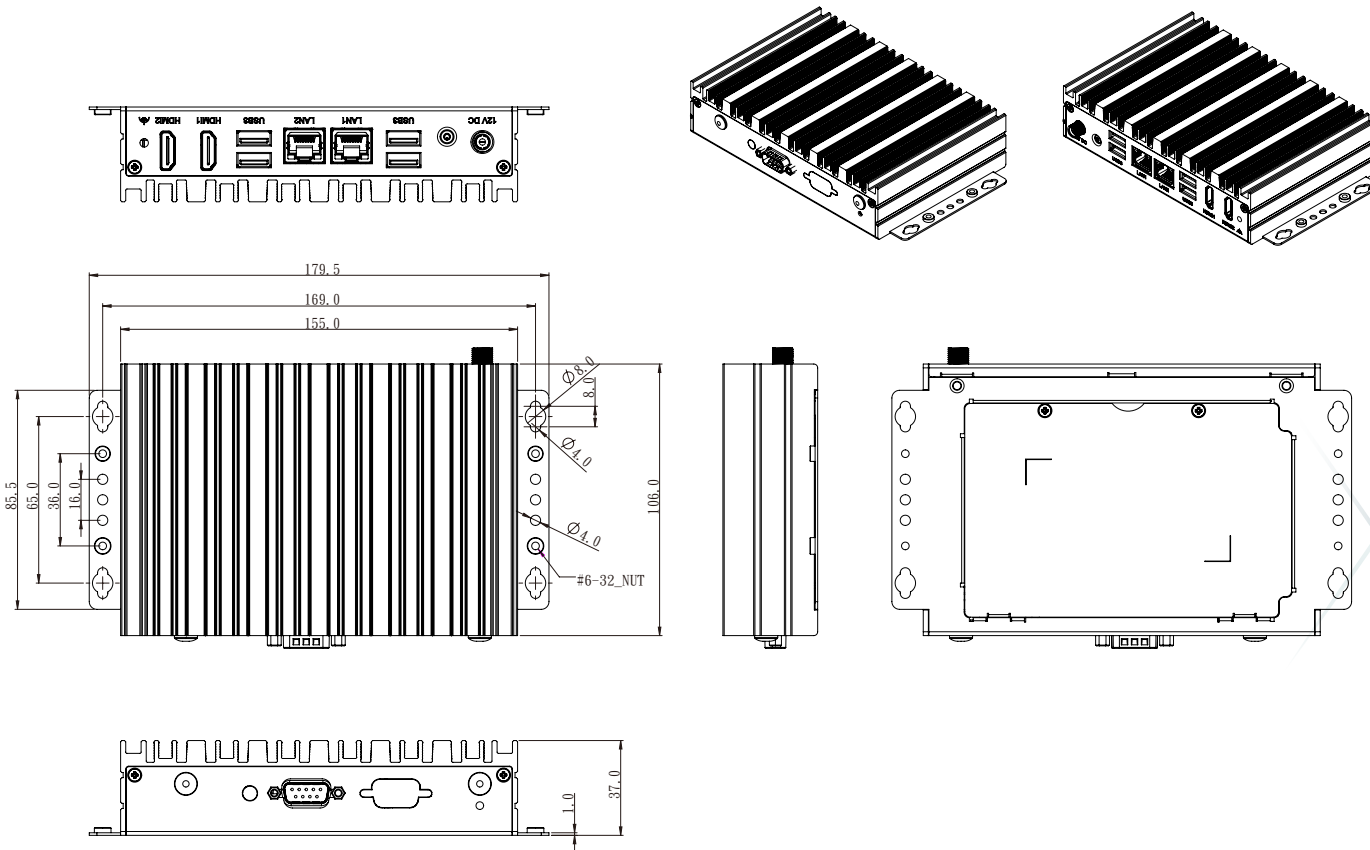

Neu-X102-N97, Neu-X102-i3, Neu-X1025-N97, Neu-X1025-N305
 Neu-X104-i3, Neu-X1045-N355

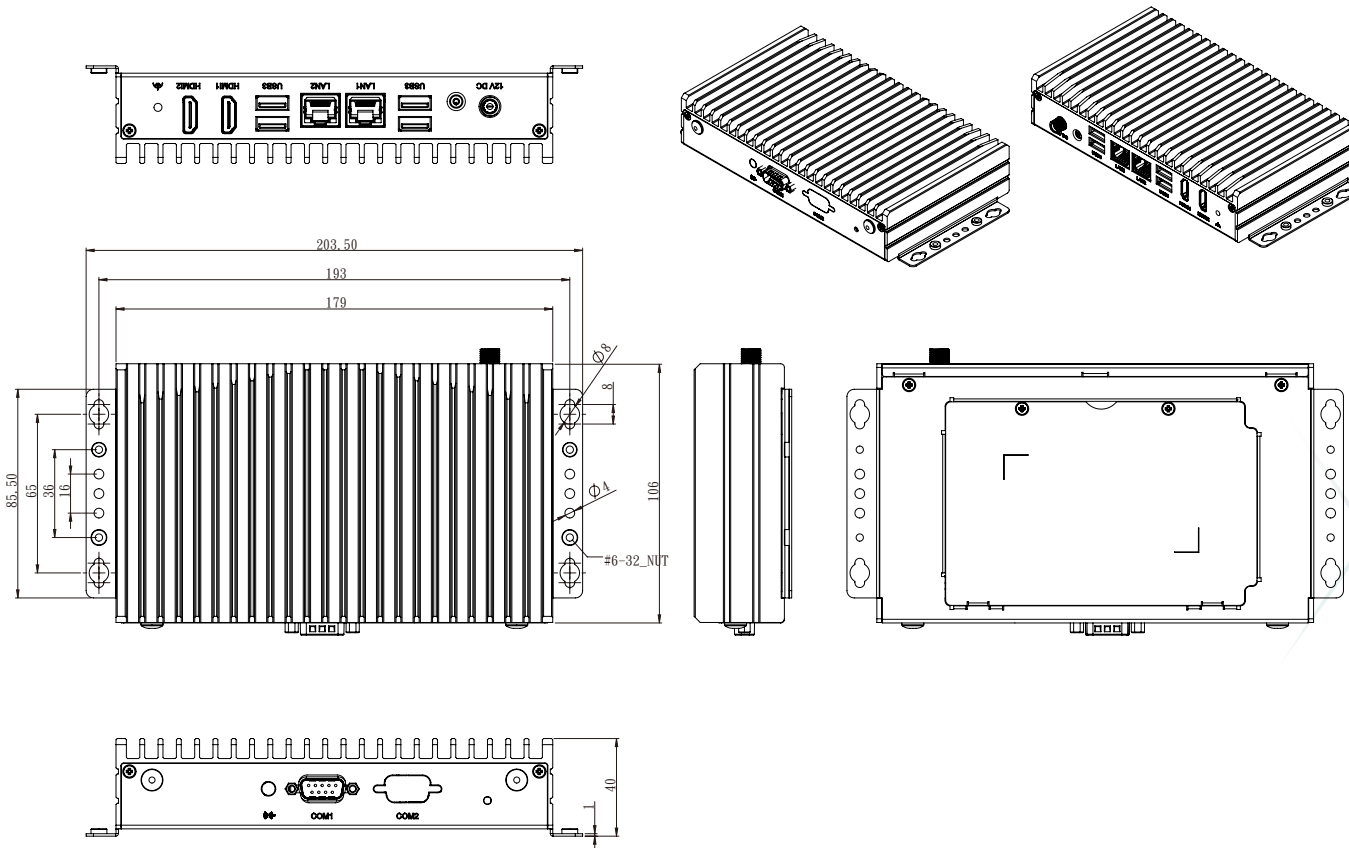

CHAPTER 2: JUMPERS AND CONNECTORS

This chapter lists the locations of the jumpers and connectors for Neu-X102/104/1025/1045 series.

Before You Begin

- Ensure you have a stable, clean working environment. Dust and dirt can get into components and cause a malfunction. Use containers to keep small components separated.
- Adequate lighting and proper tools can prevent you from accidentally damaging the internal components. Most of the procedures that follow require only a few simple tools, including the following:
 - A Philips screwdriver
 - A flat-tipped screwdriver
 - A set of jewelers screwdrivers
 - A grounding strap
 - An anti-static pad
- Using your fingers can disconnect most of the connections. It is recommended that you do not use needle-nosed pliers to disconnect connections as these can damage the soft metal or plastic parts of the connectors.
- Before working on internal components, make sure that the power is off. Ground yourself before touching any internal components, by touching a metal object. Static electricity can damage many of the electronic components. Humid environments tend to have less static electricity than dry environments. A grounding strap is warranted whenever danger of static electricity exists.

Precautions

Computer components and electronic circuit boards can be damaged by discharges of static electricity. Working on computers that are still connected to a power supply can be extremely dangerous.

Follow the guidelines below to avoid damage to your computer or yourself:

- Always disconnect the unit from the power outlet whenever you are working inside the case.
- If possible, wear a grounded wrist strap when you are working inside the computer case. Alternatively, discharge any static electricity by touching the bare metal chassis of the unit case, or the bare metal body of any other grounded appliance.
- Hold electronic circuit boards by the edges only. Do not touch the components on the board unless it is necessary to do so. Don't flex or stress the circuit board.
- Leave all components inside the static-proof packaging that they shipped with until they are ready for installation.
- Use correct screws and do not over tighten screws.

Jumper Settings

A jumper is the simplest kind of electric switch. It consists of two metal pins and a cap. When setting the jumpers, ensure that the jumper caps are placed on the correct pins. When the jumper cap is placed on both pins, the jumper is short. If you remove the jumper cap, or place the jumper cap on just one pin, the jumper is open.

Refer to the illustrations below for examples of what the 2-pin and 3-pin jumpers look like when they are short (on) and open (off).

Two-Pin Jumpers: Open (Left) and Short (Right)

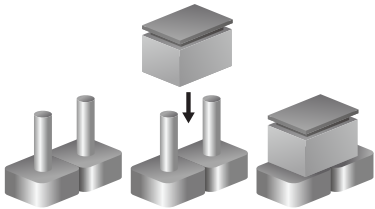

Three-Pin Jumpers: Pins 1 and 2 are Short

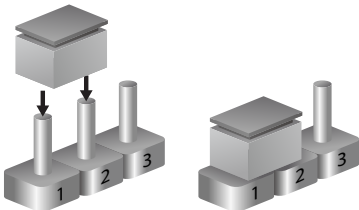

System Motherboard Overview

This chapter outlines the location and pin assignments of jumpers and connectors, with reference illustrations (not to scale) and pink-marked pin definitions to aid understanding.

Location of Jumpers and Connectors on the Motherboard

Top View

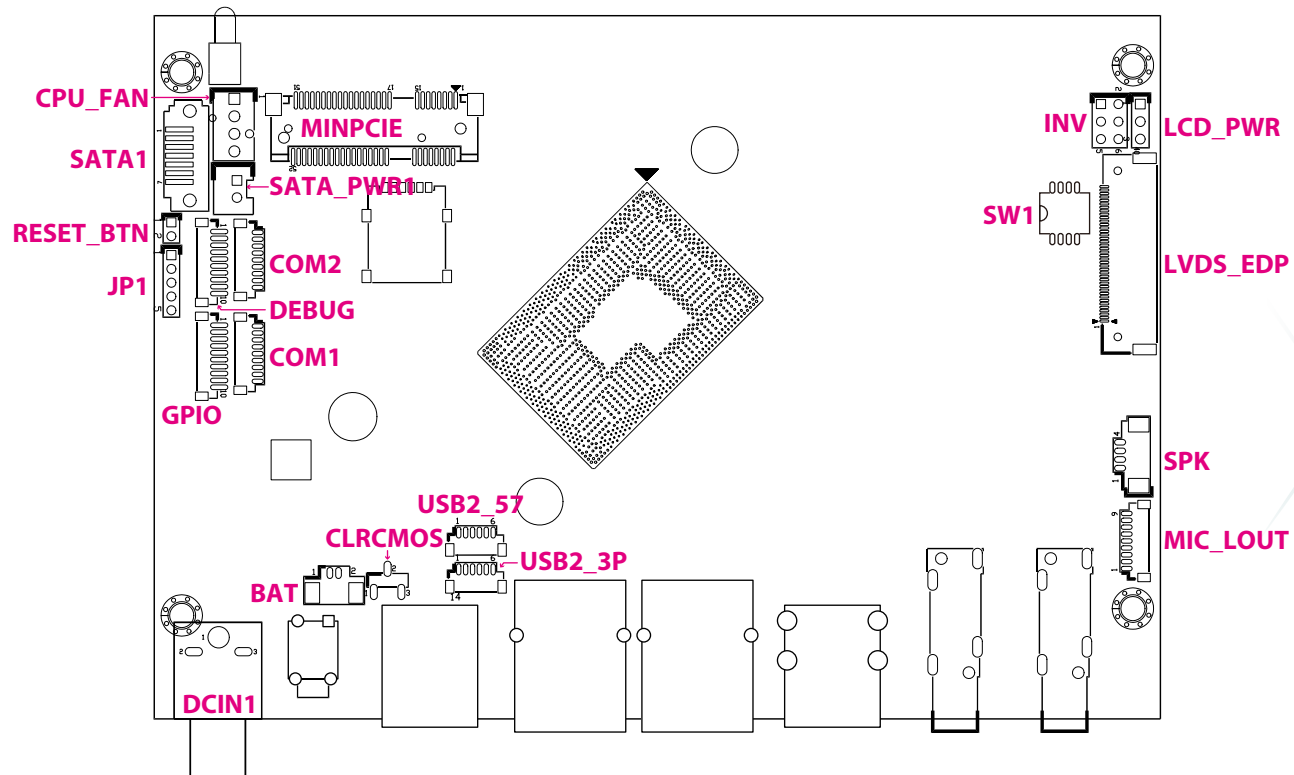

Bottom View

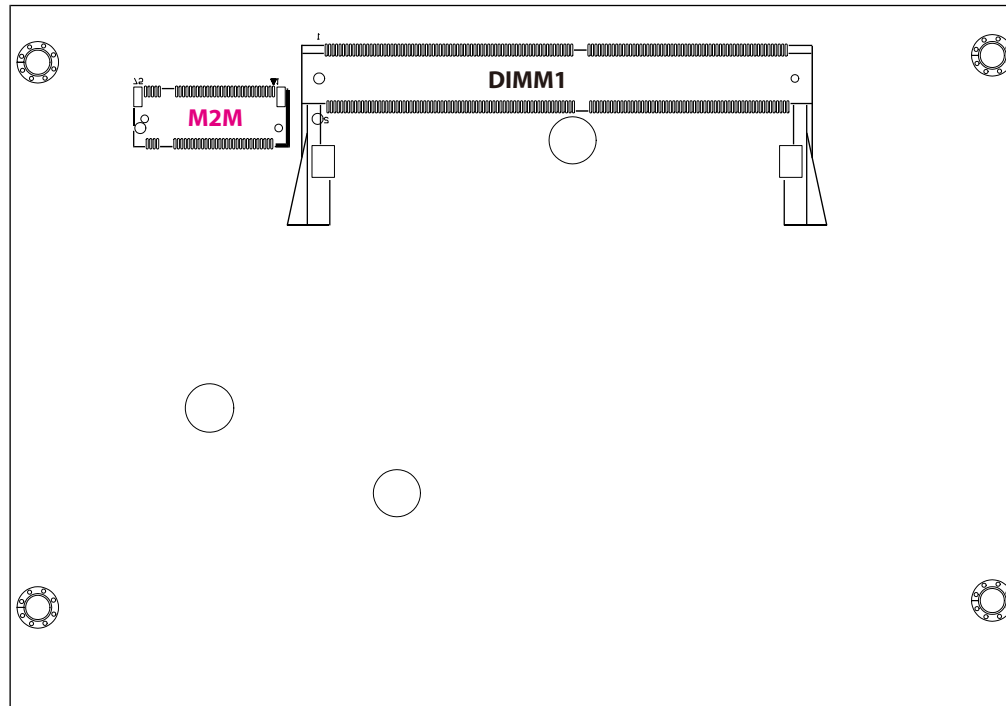

Jumpers & DIP Switches

Clear CMOS

Connector type: 1x3-pin header, 2.0mm pitch
Connector location: CLRCMOS

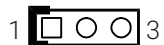

Pin	Settings
1-2 On	Normal (Default)
2-3 On	Clear CMOS

LVDS Panel Voltage Select

Connector type: 1x3-pin header, 2.0mm pitch
Connector location: LCD_PWR

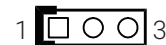

Pin	Settings
1-2 On	3.3V (Default)
2-3 On	5V

COM2 RI Select

Connector type: 1x5-pin header, 2.0mm pitch

Connector location: JP1



Pin	Settings
1	RI (Default)
2	COM2_RI (Default)
3	+5V
4	COM2_RI
5	+12V

eDP Panel Resolution Select

Connector type: 4-pin DIP switch

Connector location: SW1



SW [3:0]	SW1 [3]	SW1 [2]	SW1 [1]	SW1 [0]	HA	HA
1111	OFF	OFF	OFF	OFF	1920	1080

Default: All OFF

Connector Pin Definitions

Internal Connectors

Battery Connector

Connector type: 1x 2-pin header, 1.25mm pitch
Connector location: BAT

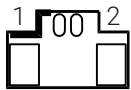

Pin	Definition
1	GND
2	BAT

COM 1 Port Header

Connector type: WtoB, 1x 9-pin header, 1.0mm pitch, supports RS-232 /422/485

Connector location: COM1

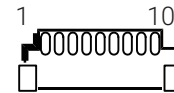

RS232		RS422		RS485	
Pin	Definition	Pin	Definition	Pin	Definition
1	RI	1	TX-	1	TR-
2	CTS	2	TX+	2	TR+
3	RTS	3	RX+	3	
4	DSR	4	RX-	4	
5	GND	5		5	
6	DTR	6		6	
7	TXD	7		7	
8	RXD	8		8	
9	DCD	9		9	

COM 2 Port Header

Connector type: WtoB, 1x 9-pin header, 1.0mm pitch, supports RS-232 only
Connector location: COM2

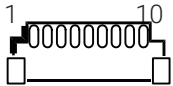

Pin	Definition	Pin	Definition
1	DCD	2	RXD
3	TXD	4	DTR
5	GND	6	DSR
7	RTS	8	CTS
9	RI		

FAN Connector

Connector type: WtoB Conn. 1x 4-pin header, 2.54mm pitch
Connector location: CPU_FAN

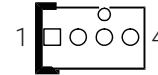

Pin	Definition
1	GND
2	+12V
3	FAN Speed Detect
4	FAN Speed Control

DC Power Input Jack

Connector type: DC Power Input Jack (+12V)

Connector location: DCIN1

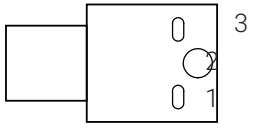

Pin	Definition
1	+12V
2	GND
3	GND

Debug Port Connector

Connector type: 1x 10-pin header, 1.0mm pitch

Connector location: DEBUG

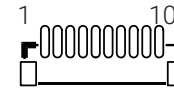

Pin	Definition	Pin	Definition
1	GND	2	PLTRST#
3	ESPI_CLK	4	ESPI_CS#
5	ESPI_I03	6	ESPI_I02
7	ESPI_I01	8	ESPI_I00
9	ESPI_RST#	10	3.3V

GPIO Connector

Connector WtoB Conn. 1x 10-pin header, 1.0mm pitch

Connector location: GPIO

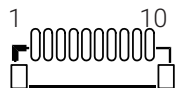

Pin	Definition	Pin	Definition
1	+5V	2	GND
3	GPO0	4	GPO1
5	GPO2	6	GPO3
7	GPI0	8	GPI1
9	GPI2	10	GPI3

LVDS Inverter Connector

Connector type: 2x3, 6-pin header JST, 2.54mm pitch

Connector location: INV

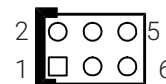

Pin	Definition	Pin	Definition
1	GND	2	GND
3	+V_INV	4	+V_INV
5	INV_BKLTEN	6	INV_BKLTCTRL

LVDS / eDP Panel Connector

Connector type: 1x 40-pin header, 0.5mm pitch

Connector location: LVDS_EDP

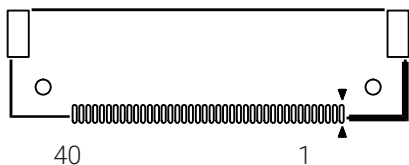

LVDS Definition			
Pin	Definition	Pin	Definition
1	LVDS_DAT3P	2	LVDS_DAT3N
3	LVDS_DAT2P	4	LVDS_DAT2N
5	LVDS_DAT1P	6	LVDS_DAT1N
7	LVDS_DAT0P	8	LVDS_DAT0N
9	LVDS_DAT7P	10	LVDS_DAT7N
11	LVDS_DAT6P	12	LVDS_DAT6N
13	LVDS_DAT5P	14	LVDS_DAT5N
15	LVDS_DAT4P	16	LVDS_DAT4N
17	GND	18	+V_PANEL
19	+V_PANEL	20	+V_PANEL

LVDS Definition			
Pin	Definition	Pin	Definition
21	GND	22	+V_PANEL
23	GND	24	GND
25	GND	26	LVDS_CLK1P
27	LVDS_CLK1N	28	GND
29	GND	30	GND
31	Hot-Plug Detect	32	INV_BKLTEN
33	INV_BKLTCTRL	34	LVDS_CLK2P
35	LVDS_CLK2N	36	+V_INV
37	+V_INV	38	+V_INV
39	+V_INV	40	N.C.

eDP Definition			
Pin	Definition	Pin	Definition
1	N.C.	2	N.C.
3	EDP_TX0P	4	EDP_TX0N
5	EDP_TX1P	6	EDP_TX1N
7	EDP_HPD	8	N.C.
9	N.C.	10	N.C.
11	N.C.	12	N.C.
13	N.C.	14	N.C.
15	N.C.	16	N.C.
17	GND	18	+V_PANEL
19	+V_PANEL	20	+V_PANEL

eDP Definition			
Pin	Definition	Pin	Definition
21	GND	22	+V_PANEL
23	GND	24	GND
25	GND	26	EDP_AUXP
27	EDP_AUXN	28	GND
29	GND	30	GND
31	Hot-Plug Detect	32	INV_BKLTEN
33	INV_BKLTCTRL	34	N.C.
35	N.C.	36	+V_INV
37	+V_INV	38	+V_INV
39	+V_INV	40	GND

M.2 Key M Connector

Connector Type: M.2 Key M, 2242 (supports SATA and PCIe Gen 3x1)

Connector location: M2M

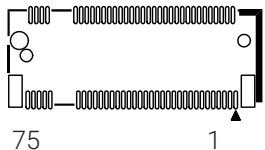

Pin	Definition	Pin	Definition
1	GND	2	VCC3
3	GND	4	VCC3
5	PCIEX_RXN	6	NC
7	PCIEX_RXP	8	NC
9	GND	10	M2M_LED#
11	PCIEX_TXN	12	VCC3
13	PCIEX_TXP	14	VCC3
15	GND	16	VCC3
17	PCIEX_RXN	18	VCC3
19	PCIEX_RXP	20	NC
21	GND	22	NC
23	PCIEX_TXN	24	NC
25	PCIEX_TXP	26	NC
27	GND	28	NC
29	PCIEX_RXN	30	NC
31	PCIEX_RXP	32	NC

Pin	Definition	Pin	Definition
39	GND	40	NC
41	SATA_RXP(PCIEX_RXP)	42	NC
43	SATA_RXN(PCIEX_RXN)	44	NC
45	GND	46	NC
47	SATA_TXN(PCIEX_TXN)	48	NC
49	SATA_TXP(PCIEX_TXP)	50	RESET#
51	GND	52	CLKREQ#
53	CLK_PCIEEN	54	WAKE#
55	CLK_PCIEP	56	NC
57	GND	58	NC
67	NC	68	NC
69	M2M_PEDET	70	VCC3
71	GND	72	VCC3
73	GND	74	VCC3
75	GND		

MIC-in & Line-out Connector

Connector type: 1x 9-pin header, 1.0mm pitch

Connector location: MIC_LOUT

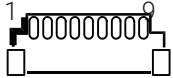

Pin	Definition	Pin	Definition
1	LINE_OUT-R	2	LINE_JD
3	AUDGND	4	LINE_OUT-L
5	AUDGND	6	MIC_OUT-R
7	MIC_JD	8	MIC_OUT-L
9	AUDGND		

Mini PCIe Connector

Connector location: MINIPCIE

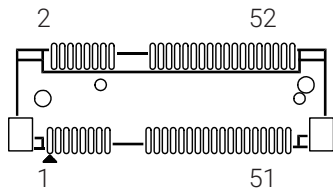

Pin	Definition	Pin	Definition
1	WAKE#	2	3.3V
3	NC	4	GND
5	NC	6	1.5V
7	CLKREQ#	8	UIM_PWR
9	GND	10	UIM_DATA
11	CLKN0	12	UIM_CLK
13	CLKP0	14	UIM_RESET
15	GND	16	UIM_VPP
17	NC	18	GND
19	NC	20	W_DIS#
21	GND	22	RESET#
23	PCIE5_RXN / SATA_RXP	24	3.3V
25	PCIE5_RXP / SATA_RXN	26	GND

Pin	Definition	Pin	Definition
27	GND	28	1.5V
29	GND	30	SMB_CLK
31	PCIE5_TXN / SATA_TXN	32	SMB_DATA
33	PCIE5_TXP / SATA_TXP	34	GND
35	GND	36	USB2_6DN
37	GND	38	USB2_6DP
39	3.3V	40	GND
41	3.3V	42	NC
43	GND	44	NC
45	NC	46	NC
47	NC	48	1.5V
49	NC	50	GND
51	mSATA Presece Detection	52	3.3V

System Reset Connector

Connector type: 1x 2-pin header, 2.0mm pitch

Connector location: RESET_BTN



Pin	Definition
1	GND
2	RESET#

SATA Connector

Connector type: 1x 7P, 1.27mm

Connector location: SATA1

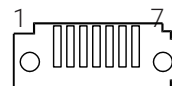

Pin	Definition
1	GND
2	SATA_TXP
3	SATA_TXN
4	GND
5	SATA_RXN
6	SATA_RXP
7	GND

SATA Power Connector

Connector type: WtoB Con. 1x 2-pin header, 2.5mm

Connector location: SATA_PWR1

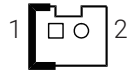

Pin	Definition
1	+5V
2	GND

Speaker Connector

Connector type: 1x 4-pin header, 1.25mm pitch

Connector location: SPK

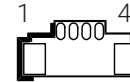

Pin	Definition	Pin	Definition
1	L_OUT+	2	L_OUT-
3	R_OUT+	4	R_OUT-

USB 2.0 Connector

Connector type: 1x 6-pin header, 1.0mm for 2x USB 2.0 port

Connector location: USB2_57

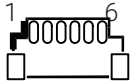

Pin	Definition	Pin	Definition
1	GND	2	USB5N
3	USB5P	4	USB7N
5	USB7P	6	+5V

USB 2.0 Connector

Connector type: 1x 6-pin header, 1.0mm for 1x USB 2.0 port

Connector location: USB2_3P

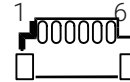

Pin	Definition	Pin	Definition
1	GND	2	NC
3	NC	4	USB3N
5	USB3P	6	+5V

Block Diagram

DDR4 Models

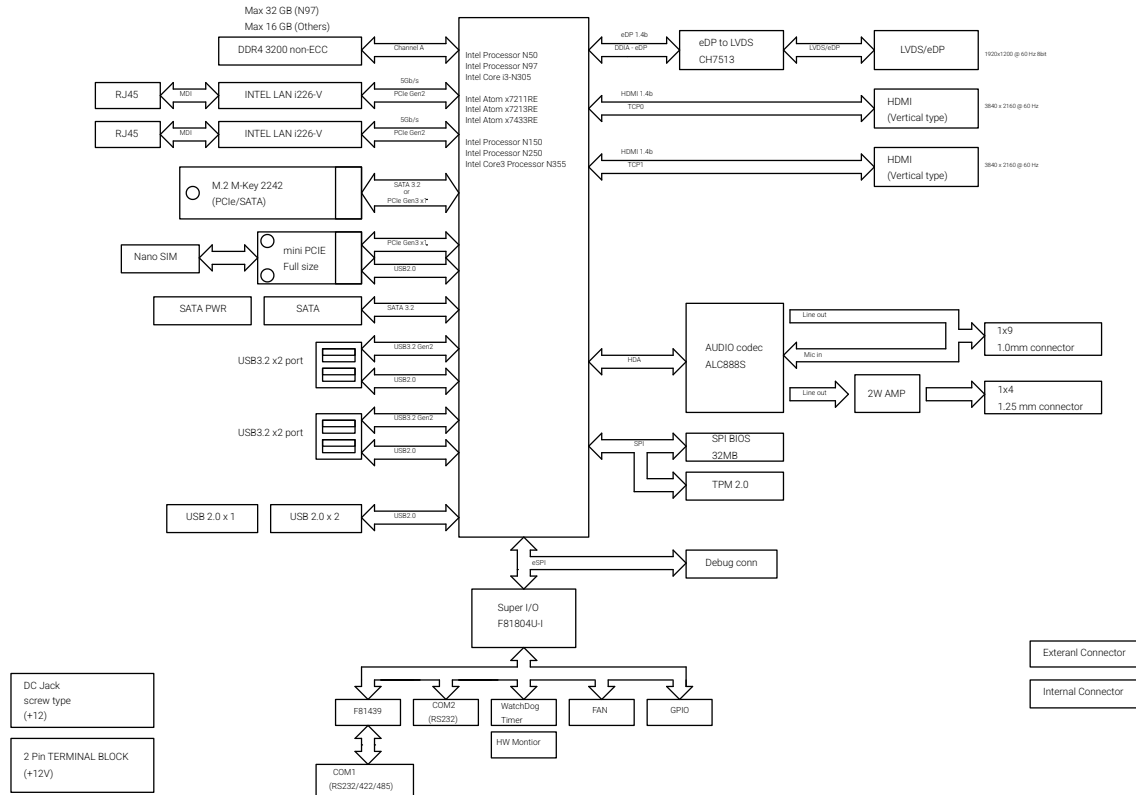

DDR5 Models

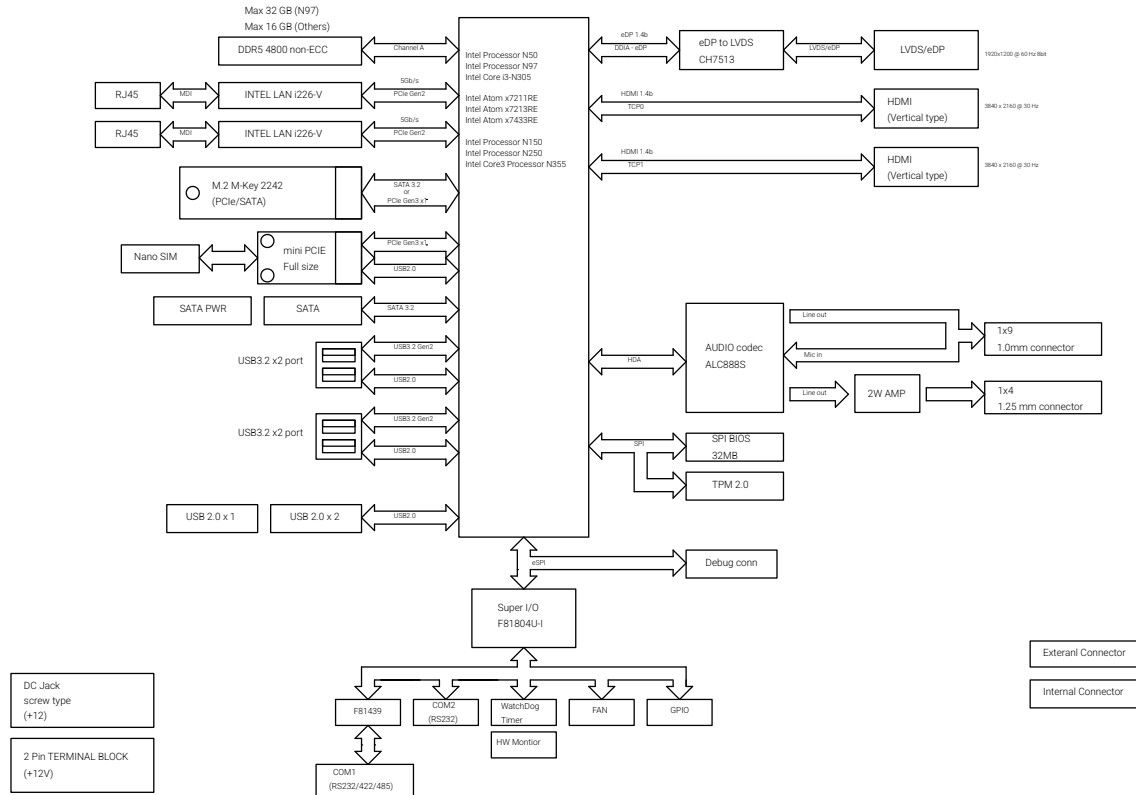

CHAPTER 3: SYSTEM SETUP

Installing a SO-DIMM Memory Module & M.2 Key M SSD Module (2242)

1. Loosen the screws on the bottom cover, and remove the cover from the chassis.

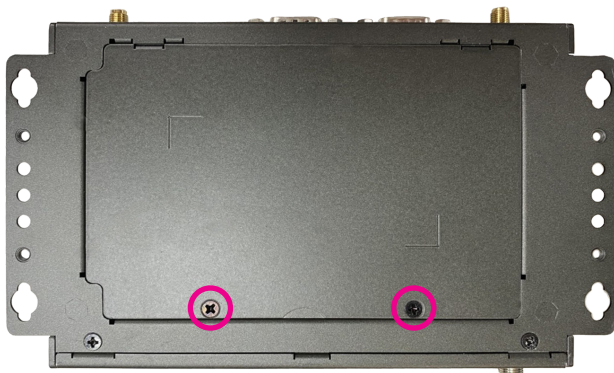

2. Insert the M.2 SSD module into the M.2 slot at a 45 degree angle until the gold-plated connector on the edge of the module completely disappears inside the slot. With the module fully inserted, tighten a screw into the mounting hole on the module to secure it. Then, install a memory module into the SO-DIMM socket. Insert the module into the socket at an approximately 30 degree angle. Push the module down until the clips on both sides of the socket lock into position. The gold-plated connector on the edge of the module will almost completely disappear inside the socket.

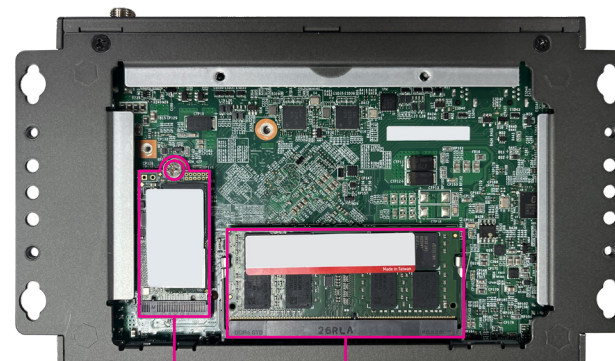

M.2 Key M Slot SO-DIMM Socket

Installing a Wi-Fi or LTE Module (Mini PCIe Slot)

- Remove the 4 screws from the front and rear panels, then remove the chassis cover.



Installing a Wi-Fi Module

1. With the chassis cover removed, locate the mini-PCIe slot on the board.
2. Tighten the bracket ([506900226X00](#)) with the Wi-Fi module using the bundled screws ([50311F0330X00](#), 2pcs).
3. Insert the Wi-Fi module into the slot at a 45 degree angle until the gold-plated connector on the edge of the module completely disappears inside the slot.
4. Tighten the screw ([50311F0295X00](#)) through the mounting hole on the secured bracket to the standoff on the motherboard.
5. Attach the RF cables onto the Wi-Fi module and insert the antenna jack end of the cables through the antenna holes. Refer to [Assembling the Antennas](#) section for more details.

Standoff for securing the Wi-Fi module with the bracket.

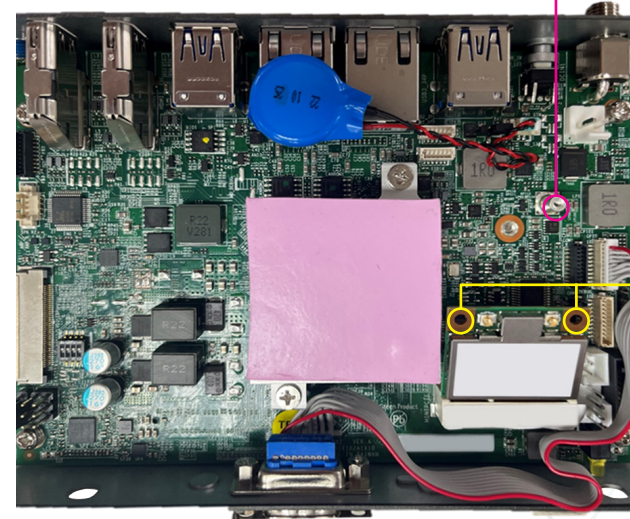

Module holes for tightening the bracket with the bundled screws. Note that the module in this image is not screwed to the bracket.

Installing an LTE Module

1. With the chassis cover removed, locate the mini PCIe slot on the board.
2. Insert the LTE module into the slot at a 45 degree angle until the gold-plated connector on the edge of the module completely disappears inside the slot.
3. Tighten the screw (50311F0295X00) through the mounting hole on the LTE module to the standoff on the motherboard.
4. Attach the RF cables to the LTE module and insert the antenna jacks end of the cables through the antenna holes. Refer to [Assembling the Antennas](#) section for more details.

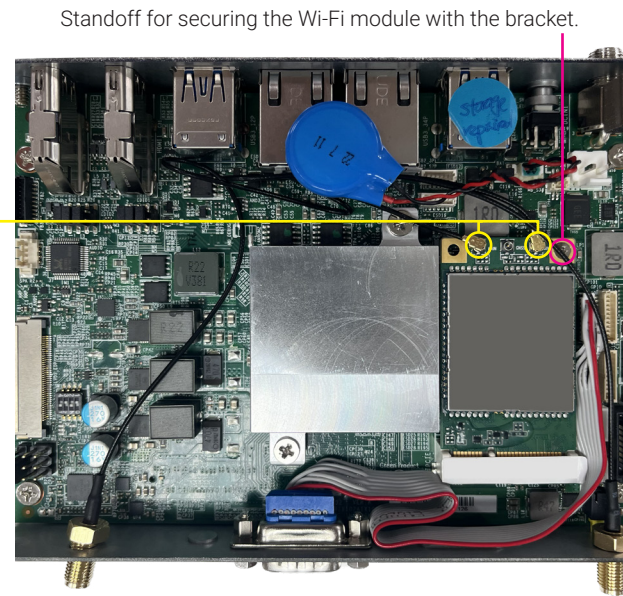
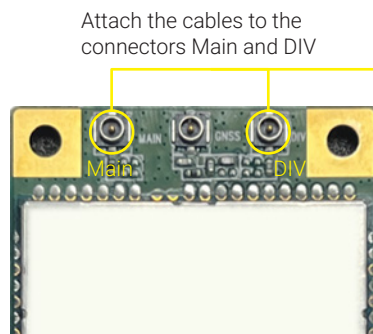

Assembling the Antennas

1. Remove the two antenna hole covers on the front panel.
2. Insert the 2 rings (ring 1 then ring 2) into the Wi-Fi/LTE antenna jacks.

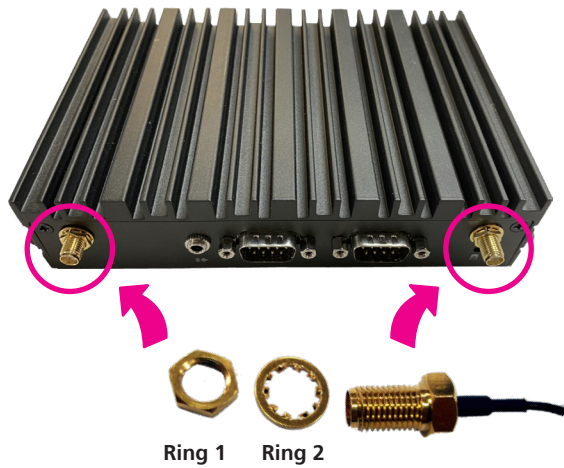

3. Connect the external antennas to the Wi-Fi antenna jacks.



Assembling the Remote Switch Cable

- The remote switch cable is equipped with a TRS (Tip-Ring-Sleeve) plug connector. Refer to the image below for the positions of the positive and negative electrodes.



Remote power switch cable P/N: 603POW0701X00



This cable does not support hot-plugging; the positive electrode may contact the negative electrode during insertion or removal of the jack.

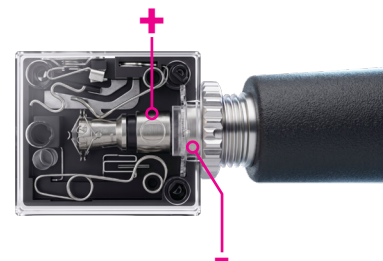

The image shown here is an example for instructional reference.

CHAPTER 4: BIOS SETUP

This chapter describes how to use the BIOS setup program for Neu-X102/104/1025/1045 series. The BIOS screens provided in this chapter are for reference only and may change if the BIOS is updated in the future.

To check for the latest updates and revisions, visit the NEXCOM website at www.nexcom.com.tw.

About BIOS Setup

The BIOS (Basic Input and Output System) Setup program is a menu driven utility that enables you to make changes to the system configuration and tailor your system to suit your individual work needs. It is a ROM-based configuration utility that displays the system's configuration status and provides you with a tool to set system parameters.

These parameters are stored in non-volatile battery-backed-up CMOS RAM that saves this information even when the power is turned off. When the system is turned back on, the system is configured with the values found in CMOS.

With easy-to-use pull down menus, you can configure such items as:

- Hard drives, diskette drives, and peripherals
- Video display type and display options

- Password protection from unauthorized use
- Power management features

The settings made in the setup program affect how the computer performs. It is important, therefore, first to try to understand all the setup options, and second, to make settings appropriate for the way you use the computer.

When to Configure the BIOS

- This program should be executed under the following conditions:
- When changing the system configuration
- When a configuration error is detected by the system and you are prompted to make changes to the setup program
- When resetting the system clock
- When redefining the communication ports to prevent any conflicts
- When making changes to the Power Management configuration
- When changing the password or making other changes to the security setup

Normally, CMOS setup is needed when the system hardware is not consistent with the information contained in the CMOS RAM, whenever the CMOS RAM has lost power, or the system features need to be changed.

Default Configuration

Most of the configuration settings are either predefined according to the Load Optimal Defaults settings which are stored in the BIOS or are automatically detected and configured without requiring any actions. There are a few settings that you may need to change depending on your system configuration.

Entering Setup











When the system is powered on, the BIOS will enter the Power-On Self Test (POST) routines. These routines perform various diagnostic checks; if an error is encountered, the error will be reported in one of two different ways:

- If the error occurs before the display device is initialized, a series of beeps will be transmitted.
- If the error occurs after the display device is initialized, the screen will display the error message.

Powering on the computer and immediately pressing allows you to enter Setup.

Press the  key to enter Setup:

Legends

Key	Function
	Moves the highlight left or right to select a menu.
	Moves the highlight up or down between sub-menus or fields.
	Exits the BIOS Setup Utility.
	Scrolls forward through the values or options of the highlighted field.
	Scrolls backward through the values or options of the highlighted field.
	Selects a field.
	Displays General Help.
	Load previous values.
	Load optimized default values.
	Saves and exits the Setup program.
	Press <Enter> to enter the highlighted sub-menu

Scroll Bar

When a scroll bar appears to the right of the setup screen, it indicates that there are more available fields not shown on the screen. Use the up and down arrow keys to scroll through all the available fields.

Submenu

When "▶" appears on the left of a particular field, it indicates that a submenu which contains additional options are available for that field. To display the submenu, move the highlight to that field and press  .

BIOS Setup Utility

Once you enter the AMI BIOS Setup Utility, the Main Menu will appear on the screen. The main menu allows you to select from several setup functions and one exit. Use arrow keys to select among the items and press  to accept or enter the submenu.

Main

The Main menu is the first screen that you will see when you enter the BIOS Setup Utility.

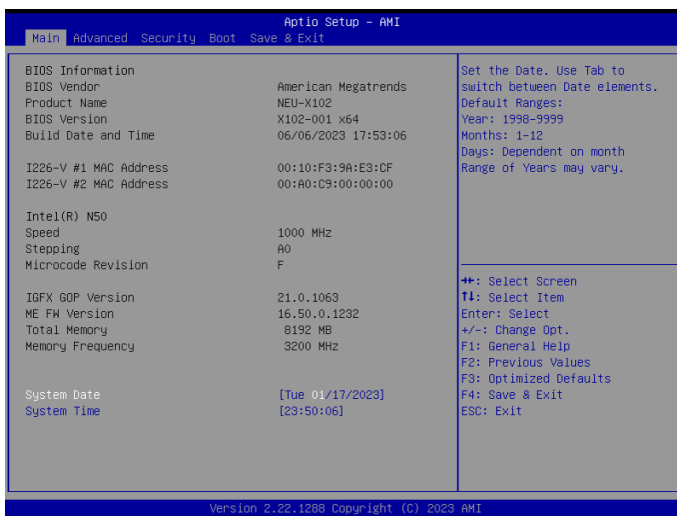

System Date

The date format is <day>, <month>, <date>, <year>. Day displays a day, from Monday to Sunday. Month displays the month, from January to December. Date displays the date, from 1 to 31. Year displays the year, from 2005 to 2099.

System Time

The time format is <hour>, <minute>, <second>. The time is based on the 24-hour military-time clock. For example, 1 p.m. is 13:00:00. Hour displays hours from 00 to 23. Minute displays minutes from 00 to 59. Second displays seconds from 00 to 59.

Advanced

The Advanced menu allows you to configure your system for basic operation. Some entries are defaults required by the system board, while others, if enabled, will improve the performance of your system or let you set some features according to your preference.



Setting incorrect field values may cause the system to malfunction.

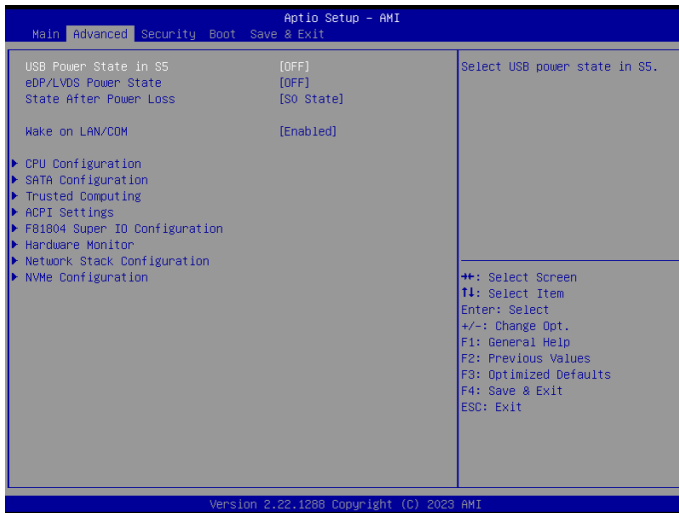

USB Power State in S5

Select USB Power State in S5. The default is **OFF**.

eDP/LVDS Power State

Select eDP/LVDS Power controller state. The default is **OFF**.

State After Power Loss

Configure the power state when power is re-applied after a power failure (G3 state).

Wake on LAN/COM

Enable or Disable the integrate LAN & COM port RI to wake the system.

CPU Configuration

This section is used to configure the CPU.

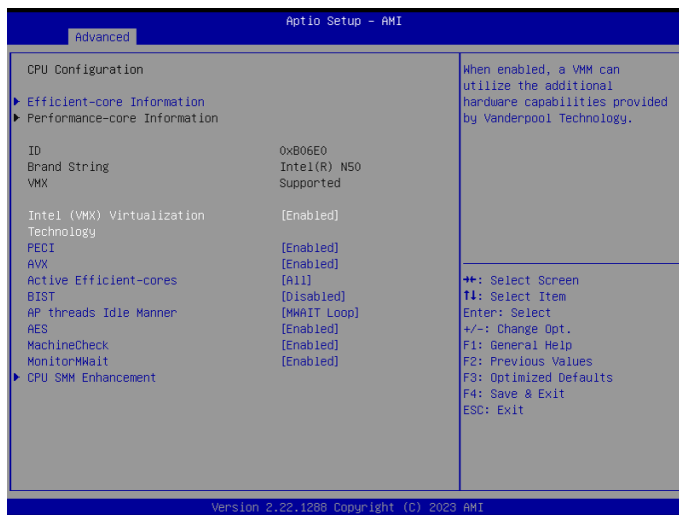

Efficient the E-core Information

Enter the sub-menu of Efficient the E-core Information.

Intel® (VMX) Virtualization Technology

When this field is set to Enabled, the VMM can utilize the additional hardware capabilities provided by Vanderpool Technology.

PECI

Enable or Disable PECI (Platform Environment Control Interface).

AVX

Enable or disable the AVX 2 instructions. This is applicable for Performance-core only.

Active Efficient-Cores

This allows you to select the number of E-cores to enable in each processor package. **NOTE:** Number of P-Cores and E-Cores are looked at together. When both are {0,0}, Pcode will enable all cores.

BIST

Enable or disable BIST (Built-in Self Test) on reset.

AP Threads Idle Manner

AP Threads Idle Manner for waiting signal to run.

AES

Enable or Disable AES (Advanced Encryption Standard).

MachineCheck

Enable or disable Machine Check.

MonitorMwait

Enable or disable MonitorMwait; If disable MonitorMwait, the AP threads Idle Manner should not set in MWAIT Loop.

CPU SMM Enhancement

This section displays information of CPU System Management Mode Enhancement.



SMM Use Delay Indication

Enable or disable usage of SMM_DELAYED MSR for MP sync in SMI.

SMM Use Block Indication

Enable or disable usage of SMM_BLOCKED MSR for MP sync in SMI.

SMM Use SMM en-US Indication

Enable or disable usage of SMM_ENABLE MSR for MP sync in SMI.

SATA Configuration

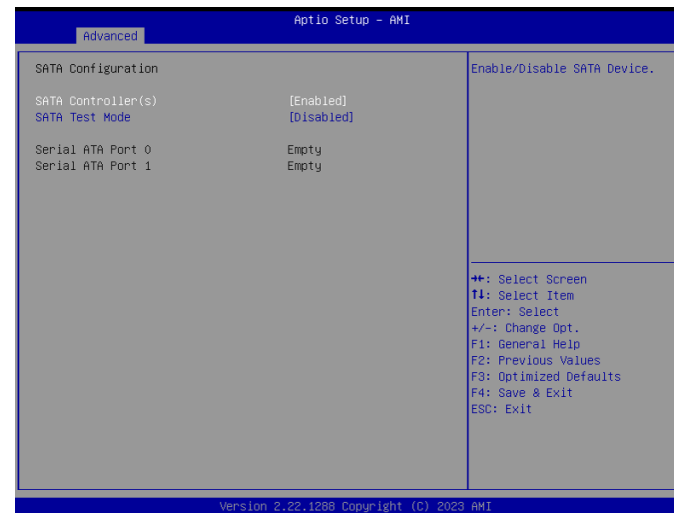

SATA Controller(s)

Enable or Disable SATA devices

SATA Test Mode

Enable or Disable SATA Test mode. The default is **Disable**.

Trusted Computing

This section is used to configure Trusted Platform Module (TPM) settings.



Security Device Support

Enable or disable BIOS support for security device. O.S will not show Security Device. TCG EFI protocol and INT1A interface will not be available.

SHA256 PCR Bank

Enable or disable SHA256 PCR Bank.

Pending operation

Schedule an operation for the security device.

Platform Hierarchy

Enable or disable Platform Hierarchy.

Storage Hierarchy

Enable or disable Storage Hierarchy.

Endorsement Hierarchy

Enable or disable Endorsement Hierarchy.



The system will reboot during restart in order to change state of security device.

Trusted Computing

This section is used to configure ACPI settings.



Enable Hibernation

Enable or disable system ability to hibernate (OS/S4 Sleep State). This option may not be effective with some operating systems.

ACPI Sleep State

Select the highest ACPI sleep state the system will enter when the suspend button is pressed. The options are Suspend Disabled and S3 (Suspend to RAM).

F81804 Super IO Configuration

This section is used to configure the serial ports.



Super IO Chip

Display the Super I/O chip used on the board.

Serial Port 1 & 2 Configuration

Enter the sub-menu of Serial port 1 & 2 for configuration.

Serial Port 1/2 Configuration

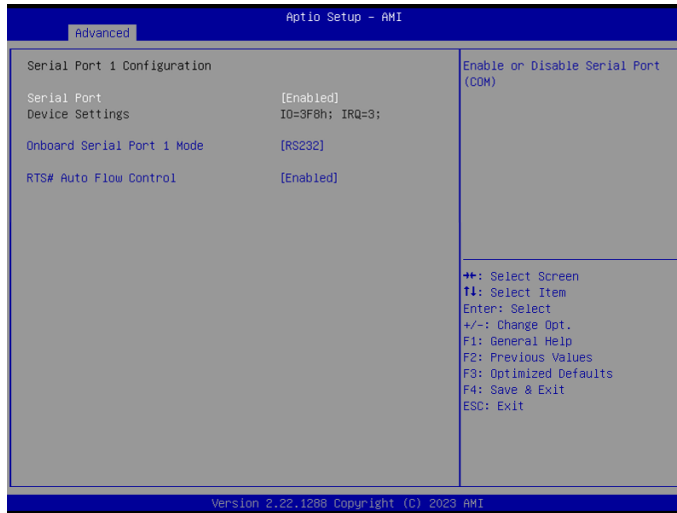

Serial Port (Port 1/2)

Enable or disable the serial port.

Device Settings (Port 1/2)

Display the IO address and IRQ of the serial COM port.

Onboard Serial Port 1 Mode

Select this to change the serial port mode to RS232, RS422, or RS485.

RTS# Auto Flow Control

Enable or disable RTS# Auto Flow Control.

Hardware Monitor

This section is used to monitor hardware status such as temperature, fan speed, and voltages.

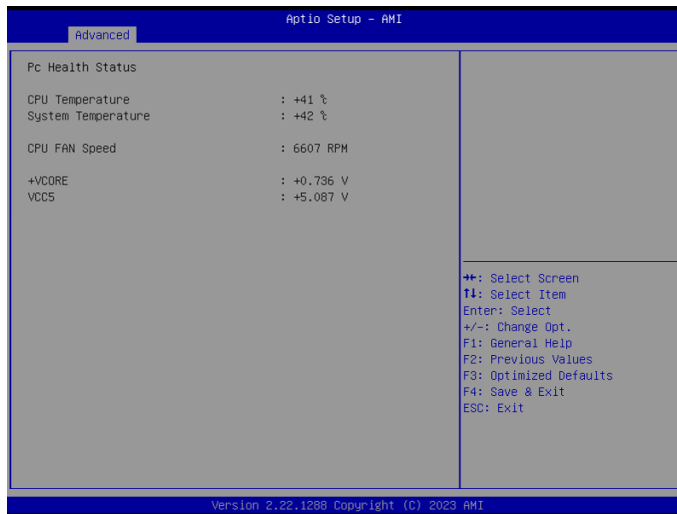

CPU Temperature

Detect and display the current CPU temperature.

System Temperature

Detect and display the current system temperature.

CPU Fan Speed

Detect and display the current CPU fan speed.

VDDCORE

Detect and display the CPU voltages.

VCC5

Detect and display the 5V voltages.

Network Stack Configuration

This section is used to configure the network stack settings.

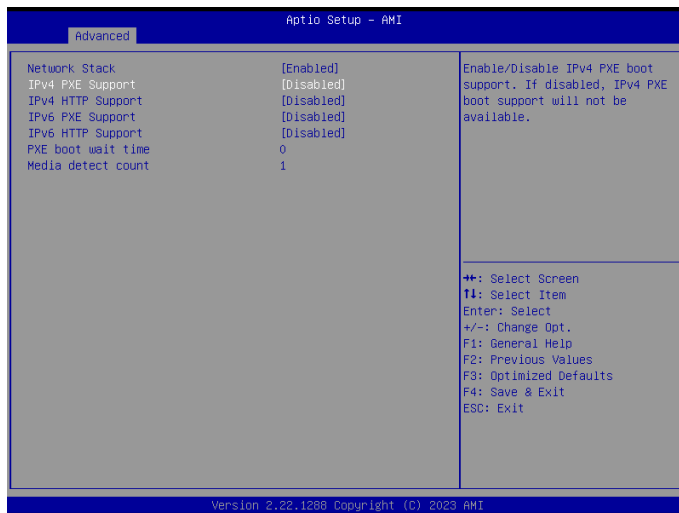

Network Stack

Enable or disable UEFI network stack.

Ipv4 PXE Support

Enable or disable IPv4 PXE support. If disabled, the IPv4 boot option will not be created.

Ipv4 HTTP Support

Enable or disable Ipv4 HTTP support. If disabled, the IPv4 HTTP boot option will not be available.

Ipv6 PXE Support

Enable or disable IPv6 PXE support. If disabled, the IPv6 PXE boot option will not be available.

Ipv6 HTTP Support

Enable or disable Ipv6 HTTP support. If disabled, the IPv6 HTTP boot option will not be available.

PXE boot wait time

Configure the wait time to press the ESC key to abort the PXE boot. Use either +/- or numeric keys to set the value.

Media detect count

Configure the number of times the media will be checked. Use either +/- or numeric keys to set the value.

NVMe Configuration

This section is displayed the NVMe devices information if installed



Security

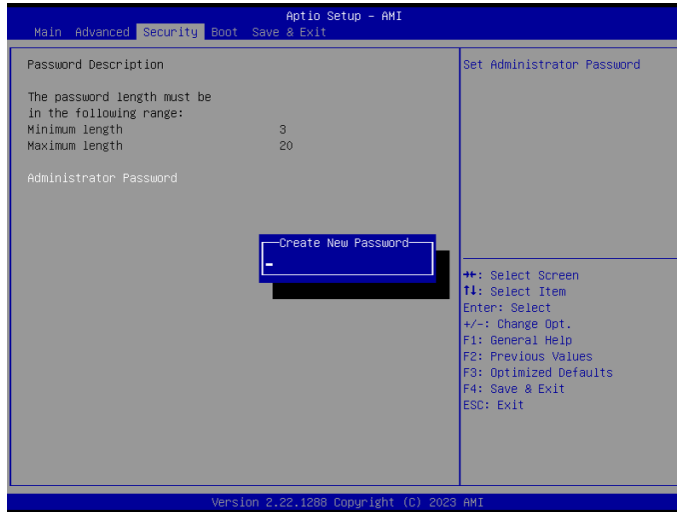

Setup Administrator Password

Select this to reconfigure the administrator's password.

Boot

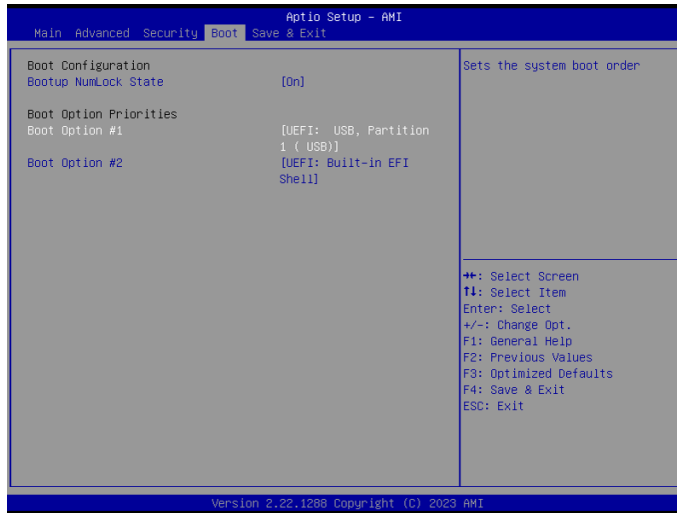

Bootup NumLock State

This allows you to determine the default state of the numeric keypad. By default, the system boots up with NumLock on wherein the function of the numeric keypad is the number keys. When set to Off, the function of the numeric keypad is the arrow keys.

Boot Option Priorities

Adjust the boot sequence of the system. Boot Option #1 is the first boot device that the system will boot from, next will be #2 and so forth.

Save & Exit



Save Changes and Exit

After save all the changes, select this field then press <Enter>. A dialog box will appear. Confirm by selecting “Yes” and then exit the system setup.

Discard Changes and Exit

To exit the Setup utility and reboot the system without saving the changes, select this field then press <Enter>. You may be prompted to confirm again before exiting.

Restore Defaults

To restore the BIOS to default settings, select this field then press <Enter>. A dialog box will appear.

Boot Override

To bypass the boot sequence from the Boot Option List and boot from a particular device, select the desired device and press <Enter>.

APPENDIX A: GPIO PROGRAMMING GUIDE

APPENDIX A: GPIO Programming Guide

GPIO (General Purpose Input/Output) pins are provided for custom system design. This appendix provides definitions and its default setting for the ten GPIO pins in the Nex-X102 series. The pin definition is shown in the following table:

Pin No.	GPIO mode	GPIO	PowerOn Default	Address
1	VCC		-	-
2	GND		-	-
3	GPIO_PIN3	GPIO_GPO0	Output High	208h (Bit2)
4	GPIO_PIN4	GPIO_GPO1	Output High	208h (Bit3)
5	GPIO_PIN5	GPIO_GPO2	Output High	208h (Bit7)
6	GPIO_PIN6	GPIO_GPO3	Output High	20Bh (Bit7)
7	GPIO_PIN7	GPIO_GPI0	Input	20Bh (Bit1)
8	GPIO_PIN8	GPIO_GPI1	Input	20Bh (Bit2)
9	GPIO_PIN9	GPIO_GPI2	Input	20Bh (Bit3)
10	GPIO_PIN10	GPIO_GPI3	Input	20Bh (Bit4)

APPENDIX B: WATCHDOG TIMER SETTING

F81804 WatchDog Programming Guide (PCB B)

```
#define WDT_SET      0x215
#define WDT_VALUE 0x216

void main(void)
{
// Enter SuperIO Configuration
outportb(WDT_VALUE, 0x03);    // Set timer 3 second.
outportb(WDT_SET, 0x31);     // Enabled WDT
                             // Use the second
                             // Use the minute, change value to 0x39
}

```